

## 10. Vents, Baffle Guard and Blocking

### 10.1 INSTALLING BATH FAN AND VENT COVER

### 10.2 INSTALLING DRYER VENT COVER

### 10.3 INSTALLING RANGE HOOD PLENUM AND VENT COVER

### 10.4 INSTALLING PROPER VENTS

### 10.5 INSTALLING WIND WASHING BAFFLE GUARD

### 10.6 INSTALLING BLOCKING

#### Tools needed by volunteers:

Hammer  
Nail apron  
Tape measure  
Square  
Utility knife  
Pencil

#### Tools and equipment needed:

Generator  
Extension cord  
Circular saw  
Chop saw  
Reciprocating saw  
Long reciprocating saw blade  
Stapler  
Framing nailer  
Torpedo level  
Stepladder  
Black crayon  
Clear varnish

#### Materials needed:

Scrap 2x lumber  
Scrap OSB  
Proper vents  
1" Foamboard  
16d Nails  
1½" Siding nails  
1⅝" Sheetrock screws  
3" Sheetrock screws  
Staples  
Air sealing tape  
HVAC tape  
Air sealing caulk  
Spray foam  
Range hood plenum  
Range vent cover  
Bath vent cover  
Bath fan

#### Personal Protection Equipment:

Safety glasses (required)

#### Reference Materials:

House Plan

**Safety First! Review the Safety Checklist before performing tasks in this chapter.**

## 10.1. ***INSTALLING BATH FAN AND VENT COVER***

1. Check for the location of the bath fan per the House Plan. It must be installed per this plan.
2. With a reciprocating saw, cut a 6" diameter hole in the OSB on the gable truss closest to the bathroom. Locate the hole adjacent the intersection of the bottom chord of the truss with a vertical member, so that the hole is **not above** and is 6"-12" away from the side of any window or door. Cutting the hole from the interior side of the gable truss will aid in hole placement.
3. Insert the tabbed end of the vent cover sleeve into the vent cover. Ensure the seam in the vent cover sleeve is positioned towards the top of the vent cover, so that it will eventually be installed on the top side of the horizontally-positioned sleeve. Cut three 4" length strips of HVAC tape and then cut these in half lengthwise. Use five of these strips to cover the circumference of the sleeve-cover connection with 1/2" overlap. Cover the four tab holes with the remaining piece of tape, cut into four pieces, or fill with caulk (see Figure 10-2 as an example).

**NOTE:** Louvers on vent cover should pivot upwards.

4. Slide the vent cover pipe through the hole made in Step 2 above, level the vent cover and nail into framing with 1½" siding nails.
5. **Check that the backdraft flap on the bath fan is working correctly by removing the factory-applied shipping tape securing the flap to the fan.**
6. Frame out an opening with 2x4's where the fan will go in the bottom chords of the trusses.
7. Mount the fan so that the bottom edge of the fan housing is located flush with the bottom edge of the truss chord.
8. Secure the fan to the framing with 1⅝" sheetrock screws. Make sure the fan's exhaust port is pointing toward the intended gable end. Set the fan body tight to the truss that the exhaust port points away from, to allow as much space as possible for the rigid duct to angle up and over the exhaust side truss's bottom chord.

## 10.2. ***INSTALLING DRYER VENT COVER***

1. Consult with the Construction Supervisor to identify the location where the hole should be cut in the rim board for the dryer vent.
2. Drill a 4⅛" hole through the rim board at the required location. The perimeter of this hole should be 2" below the underside of the floor deck and a minimum of 6" from adjacent I-joists.

3. Insert the tabbed end of the vent cover sleeve into the vent cover. Ensure the seam in the vent cover sleeve is positioned towards the top of the vent cover, so that it will eventually be installed on the top side of the horizontally-positioned sleeve. Cut three 4" length strips of HVAC tape and then cut these in half lengthwise. Use five of these strips to cover the circumference of the sleeve-cover connection with ½" overlap. Cover the four tab holes with the remaining piece of tape, cut into four pieces, or fill with caulk (see Figure 10-2 as an example).

**NOTE:** Louvers on vent cover should pivot upwards.

4. Slide the vent cover pipe through the hole made in Step 2, level the vent cover and nail into framing with 1½" siding nails.

### 10.3. INSTALLING RANGE HOOD PLENUM AND VENT COVER

#### 10.3.1. Preparing Plenum Location

1. After sheathing the exterior of the stud bay at the stove location, install the range hood plenum. Measure from the floor up 73" and mark on both studs. These marks represent the top of the plenum.
2. Cut a 2x4 plenum support block to fit between the two studs. Install the block flat with the bottom side at the 73" marks and the edge flush with the inside edge of the studs.

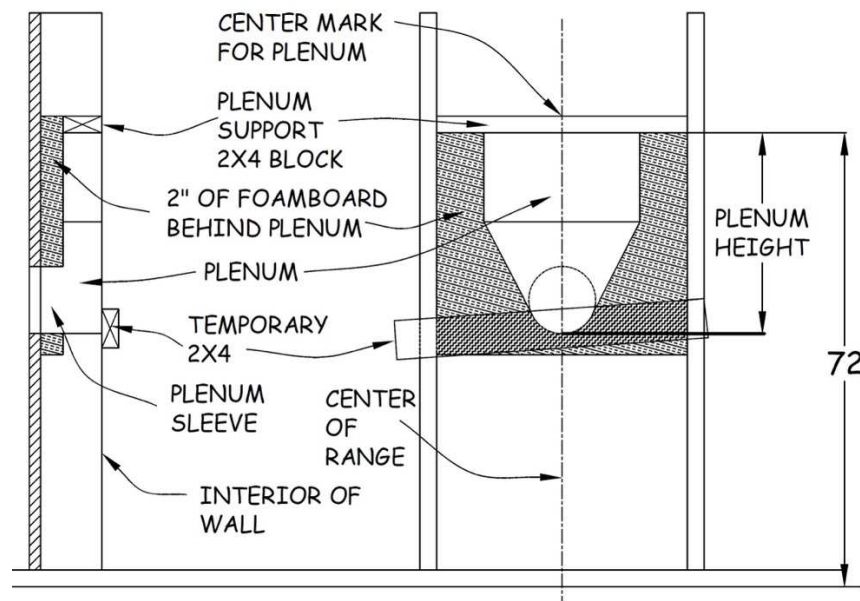

**Figure 10-1. Range Hood Plenum Location.**

3. Note the marking on the floor indicating where the center of the stove will be. Measure from the closest end wall to that center mark or, with a 6' level, plumb up from the floor mark. Mark that measurement on the 2x4 support block installed in Step 2 above ([see Figure 10-1](#)).

### 10.3.2. Preparing for Installation of the Plenum and Vent Cover

1. At the top of the plenum, measure and mark the center. Line up the plenum center mark with the 2x4 support block center mark.
2. Slide the plenum toward the exterior until the 6" diameter sleeve touches the wall sheathing.
3. Trace around the exterior of the plenum sleeve marking a 6" circle on the interior side of the sheathing. Increase the diameter of this circle by ½"-1" in order to allow room for installation of spray foam to seal the penetration in Section 10.3.3.9.
4. Cut out the larger circle in the sheathing with a reciprocating saw.

### 10.3.3. Plenum and Vent Cover Installation

1. [Measure the plenum height as shown in Figure 10-1.](#)
2. Cut 2" [thickness](#) of foamboard [slightly wider than the width of the stud bay \(for a snug fit\) and 3½" longer than the plenum height measured in Step 1.](#) Install this foamboard between the 2x4 [support block](#) and the wall sheathing, flush with the top of the 2x4 [support block](#) (see Figure 10-1). [Use tape to secure the foamboard in place if necessary.](#)
3. From outside the house sheathing, extend the circle cut out in Section 10.3.2.4 by [hand](#) cutting with a [long reciprocating saw blade](#) completely through the 2" of foamboard just installed in the previous step.
4. Align the top of the plenum and 2x4 support block center marks made in Section 10.3.2.1 above. While holding the plenum flush to the interior side of the wall framing and the 6" plenum sleeve protruding into the wall, secure the plenum to the 2x4 support block using four 1⅝" sheetrock screws through the plenum flanges.

**NOTE:** Make sure the top end of the plenum is flush with the interior edge of the wall framing.

5. Using 16d duplex nails, temporarily brace the bottom end of the plenum so it remains flush with the interior wall by nailing a piece of 2x4 across the interior edge of the two studs on either side of the plenum ([see Figure 10-1](#)).
6. [From the tabbed end, cut the vent cover sleeve to a 3" length.](#)

7. Insert the tabbed end of the vent cover sleeve into the vent cover. Ensure the seam in the vent cover sleeve is positioned towards the top of the vent cover, so that it will eventually be installed on the top side of the horizontally-positioned sleeve. Cut three 4" length strips of HVAC tape and then cut these in half lengthwise. Use five of these strips to cover the circumference of the sleeve-cover connection with 1/2" overlap. Cover the four tab holes with the remaining piece of tape, cut into four pieces, or fill with caulk (see Figure 10-2).

**NOTE:** Louvers on vent cover should pivot upwards.

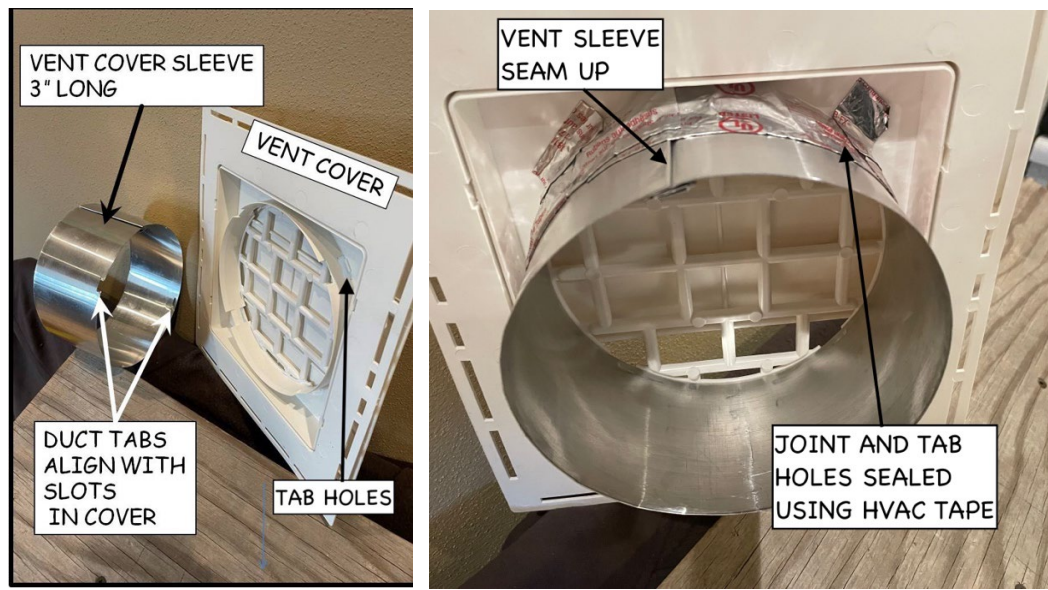

**Figure 10-2 – Range Vent Cover Sleeve Assembly**

8. From the outside, put a thick bead of air sealing caulk around the outer diameter of the plenum sleeve. Also, put a thick bead of caulk around the inner diameter of the non-tabbed end of the vent cover sleeve.
9. From the outside, spray foam, as required, around the outside diameter of the plenum sleeve at the penetration through the exterior sheathing and foamboard to completely seal the opening.
10. From outside the house, slide the vent cover sleeve through the hole in the sheathing and foamboard and over the plenum sleeve (there should be a minimum of 1½" overlap). Make sure the vent cover is tight to the exterior sheathing **AND** the entire plenum is flush, or slightly shy of the interior side of the wall framing so it does not cause an issue with wall rock installation.

**NOTE:** The connection needs to be **completely** sealed in order to prevent ANY warm exhaust air from getting into the wall cavity.

11. With a torpedo or other short level, ensure the top of the vent cover is level. Secure the vent cover in place by taping (shingle style) the flanges with flashing tape.

## 10.4. INSTALLING PROPER VENTS

1. One proper vent is placed between every truss on each side of the house. The proper vents have a flap on the bottom that is secured to the wall foamboard to prevent windwashing of the insulation.
2. To install, place the vent between the roof trusses and slide the vent toward the outside until the vent touches the foamboard. Make sure the dimples on the upper side of the proper vent are pushed up against the underside of the roof sheathing. Make sure that the bottom of the proper vent is positioned 3” above the top of the top plate (this is equivalent to the thickness of two 2x4’s). Doing this will allow proper air flow above the vent and will prevent windwashing.

**NOTE:** If a 2x4 is used as the top chord of the truss, one piece of tape can be used to cover edges on two adjacent proper vents.

3. Staple (three per side) the sides of the vent to the trusses and tape the entire width of the bottom of the flap to the foamboard and the entire length of the two sides to the trusses using air sealing tape, as shown in Figure 10-3.

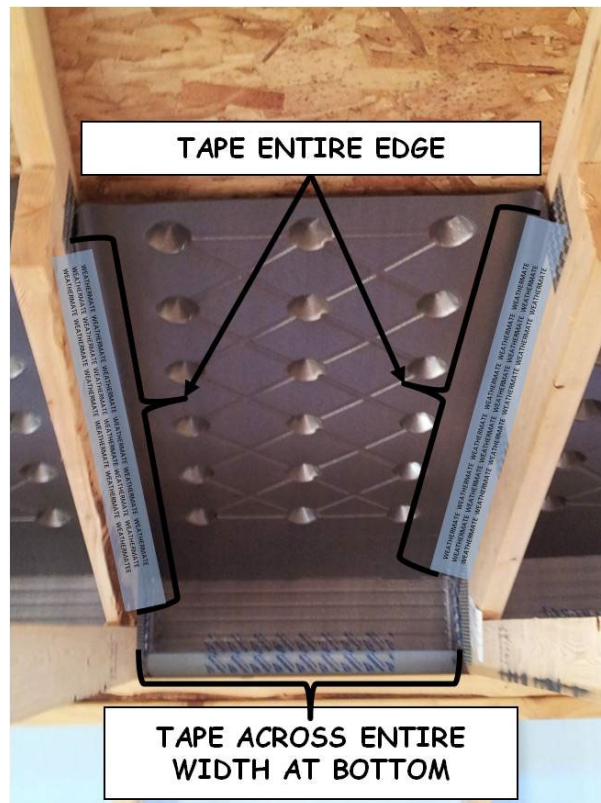

**Figure 10-3. Proper Vent Installation.**



## 10.5. INSTALLING WIND WASHING BAFFLE GUARD

1. A wind washing baffle needs to be installed on houses where the porch roof is on the eave side of the house. This baffle allows ventilation of the underside of the roof and prevents the attic insulation from being disturbed by diverting the wind up and over the insulation.
2. Install sheets of 1” foamboard between the trusses above the foamboard on the exterior wall. The sheets must extend up 24” or to within 2” of the roof sheathing (whichever is shorter). Seal all joints and gaps with air sealing tape.

## 10.6. INSTALLING BLOCKING

### 10.6.1. Safety Instruction

1. ALL blocking in stud bays MUST be installed by either hand nailing using 16d nails or secured using 3” sheetrock screws. Blocking can be secured either by toenailing through the top and bottom of the blocking into the framing stud, or by driving three screws or nails through the framing stud into the end of the blocking.

**WARNING:** Using framing nailers to install this blocking is dangerous as an improperly aimed nailer can fire a nail that misses or passes through the wood and potentially strikes a fellow worker.

### 10.6.2. Blocking for Bathroom

1. **Grab-Bar blocking:** Install this blocking adjacent to the shower and along the back side of the toilet and the wall along the side of the toilet with the TOP of the blocking 36” above the floor. Install the blocking between all studs that will NOT be covered by cabinets or the shower stall.
2. First, install the 2x6 blocking in a corner stud bay by attaching three 16d nails or 3” sheetrock screws through the open stud bay into the blocking. Secure the other end of the blocking to the corner stud by toenailing or screwing through the top and bottom of the blocking into the corner stud. Successively install blocking into the adjacent stud bays by first driving three 16d nails or 3” sheetrock screws through the open stud bay into the end of the blocking. Then, attach the opposite, common end, of the blocking by toenailing or screwing through the top and bottom of the blocking into the stud.
3. **Bathroom Mirror blocking:** Install this blocking above the vanity area (see House Plan). This will provide solid backing for mounting the mirror clip hardware positioned along the bottom and the top of the mirror.
4. Install 2x6 blocking between all studs where the vanity will be installed. Position the TOPS of the blocking at 40” and 76” above the floor.

5. **Short (18") Towel Bar blocking:** Consult the House Plan and ensure that the vanity is to be installed in a corner of the bathroom. Install 2x6 blocking in the wall along one side of the vanity, and positioned so that the TOP of the blocking is 60" above the floor and extends out at least 24" from the back corner of the vanity. If the vanity is not to be installed in a corner, consult the Construction Supervisor to locate the Short Towel Bar blocking location.
6. **Long (24") Towel Bar blocking:** Install 2x6 blocking in the wall next to the shower, and positioned so that the TOP of the blocking is 60" above the floor and extends at least 36" from the edge of the shower. If it is not possible to install the Long Towel Bar blocking next to the shower, consult Construction Supervisor about alternative installation location under the window.
7. **Linen Cabinet blocking:** Install 2x6 blocking along the back and one side of where the linen cabinet will be located. Position the blocking so that the TOP of the blocking is 60" above the floor.
8. **Toilet Paper Holder blocking:** Install in the wall next to the toilet. Install 2x6 blocking covering at least a 12" span centered 32" from the wall behind the toilet and positioned so the TOP of the blocking is 26" above the floor.
9. **Tub/Shower Nailing Flange blocking:** Select one straight (no bow or crown) 2x4 stud for blocking on the long end wall where the tub/shower unit will be installed. Install the 2x4 stud vertically on the long end wall where the nailing flange will be located. Position the face of the 2x4 stud flush with the tub-side of the long end wall. For main floor shower/tub units, position the blocking 32" to center from the back wall. For basement shower units, position the blocking 35" to center from the back wall.
10. Select one straight (no bow or crown) 2x6 stud. Install the 2x6 stud on the short end wall where the nailing flange will be located. Position the face of the 2x6 stud flush with the tub-side of the short end wall with one edge of the 2x6 stud butted up against the 2x4 forming the end of the short end wall. Attach the 2x6 stud to the 2x4 stud to create an "L-corner". This will provide stiffening to the end 2x4 stud, as well as a blocking surface for nailing flange installation.
11. **Mark Blocking Locations:** Mark on the floor with black crayon the location and purpose of blocking for the Grab Bar (GB), Long Towel Bar (LTB), Short Towel Bar (STB), and Toilet Paper Holder (TP). Spray over crayon marks with clear varnish to avoid crayon marks wearing off.

### 10.6.3. Blocking for Sheetrock

1. Blocking for sheetrock must be installed in the following areas within the house and attached garage: 1) Along the top plates of walls parallel to trusses for ceiling rock; and, 2) at the end of all interior house walls where they intersect with another wall.



- Inspect the tops of all walls for areas where blocking may be needed for ceiling rock (see Figure 10-4). For interior walls that are greater than 6" from a truss, make sure that blocking extends at least 1½"-2" beyond both ends and sides of any interior wall top plates. Blocking should be continuous at the top of each wall where required.

**NOTE:** Blocking is only required on one side of the top of interior walls that are within 6" of a truss.

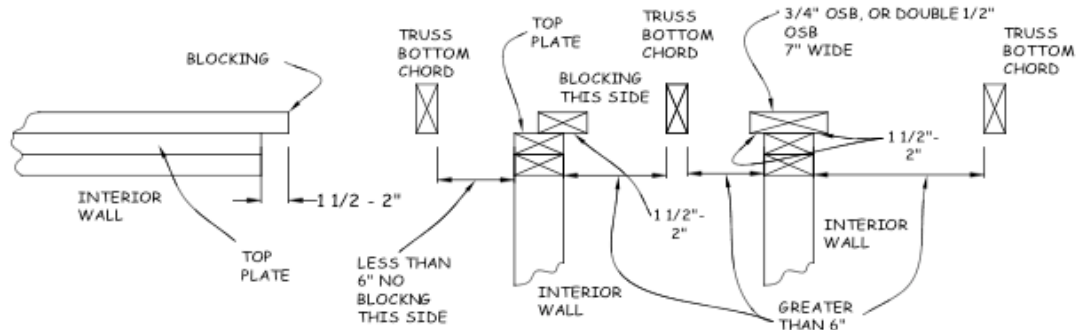

**Figure 10-4. Blocking For Ceiling Rock.**

- Use scrap 2x6, side-by-side 2x4's, ¾" OSB, or two layers of ½" OSB as long as the 1½"-2" overhang is achieved. Attach the pieces to the top of the wall with 16d nails or 3" sheetrock screws.
- Install two 43" long pieces of ¾" OSB blocking at the ends of any interior walls that intersect an exterior wall – one above the 2x4 ladder block and one below the 2x4 ladder block. The blocking must extend at least 2" beyond the edges of the stud, so cut the OSB to a width of 5½" or 7½" for a 2x4 wall and 7½" or 9½" for a 2x6 wall. Pre-drill four pairs of ³⁄₁₆" holes, spaced evenly vertically, through the stud (about ½"-¾" in from each edge). To attach the blocking, hold the piece of OSB in place, making sure it is tight (no gaps) to the outside of the end stud (use a clamp, if necessary). Attach the OSB blocking by screwing 3" sheetrock screws through the holes in the 2x4 into the OSB, turning the screw until it is buried about ¼" into the stud. If there is access to drive screws from the blocking side of stud, it is acceptable to use two layers of ½" OSB. See Figure 10-5.
- Where an interior wall intersects an interior wall (see Figure 10-5), install blocking using 2x4's, ¾" OSB, or two layers of ½" OSB. Secure the blocking to the end stud using 16d nails for 2x4 blocking and 3" sheetrock screws for OSB blocking.
- Install blocking around the perimeter of the stair landing platform to support the bottom of the wall sheet rock, since there is no bottom plate present at that level. Nail or screw 2x4s between the wall studs with the bottom at the level of the landing floor deck.

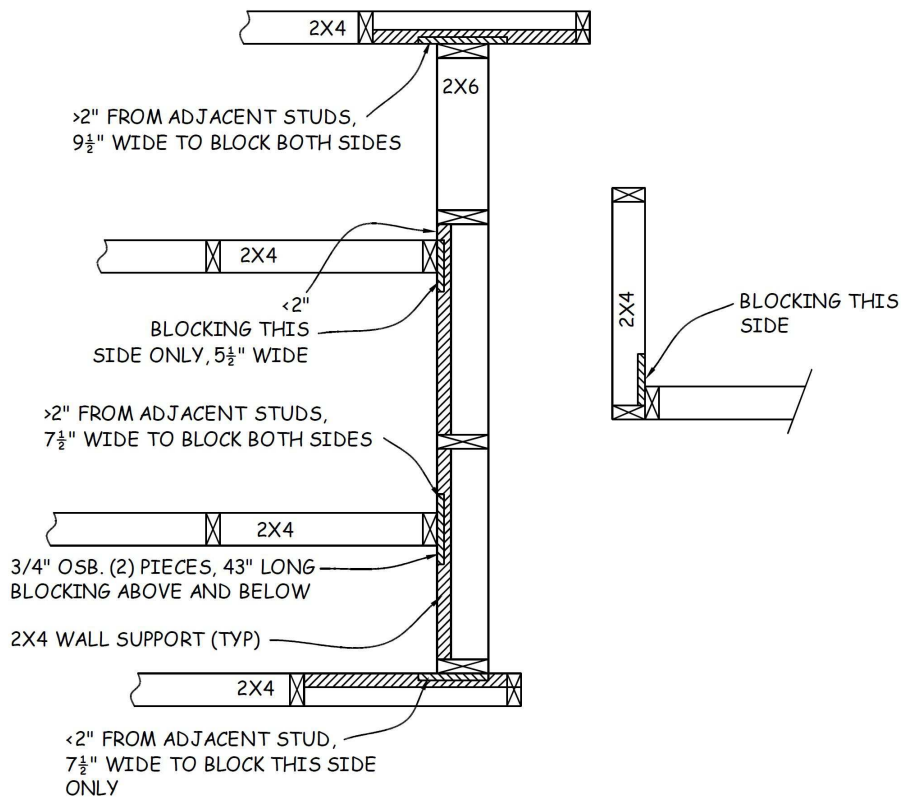

**Figure 10-5. Blocking For Wall Rock.**

#### 10.6.4. Blocking for Skirtboard

1. At the bottom of the stairs, install a piece of 2x6 or two pieces of 2x4 blocking for the skirtboard, extending from the end of the stringer to at least 5" past that point (see Figure 10-6).
2. At the top of the stairs, install a piece of 2x4 blocking where the 3/4" subfloor ends at the stair, at least 3" both above and beyond the subfloor.

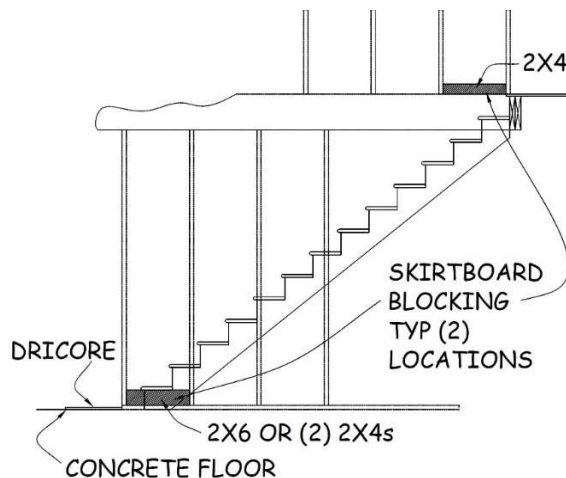

**Figure 10-6. Blocking for Skirtboard.**

### 10.6.5. Blocking for Stair Handrail

1. Straight stairways will have handrails (and require blocking) on the wall opposite the angled wall. Stairs with landing will have the handrail on the wall opposite the lower section of stairs, or the “outside” of the stairwell. The section below the landing will also require blocking.
2. The handrail bracket bottom screws will be mounted approximately 31” above a line that is defined by the nose of the treads. This will place the top of the handrail between the required 34” and 36” above the nose of the treads. To provide some latitude in the placement, measure up 32” from the decking, vertically at the edge of the floor deck, and mark the wall at that height. At the bottom of the stairs, again measure up 32” from the nose of the bottom stair tread. Snap a chalk line between the top and bottom marks. The blocking must be installed so that the top corner toward the top of the stairs is on or above this chalk line, and the bottom corner toward the bottom of the stairs is on or below this line (see Figure 10-7).
3. For blocking, use a combination of scrap 2x12’s, 2x10’s or 2 x6’s to equal a minimum height of 18” (see Figure 10-7). The extra height helps to ensure that handrail brackets will be secured to the blocking after sheetrock is installed.
4. Install blocking between the bottom two treads, the middle two treads, and the top two treads. Find the location of the middle blocking by measuring the length of the chalk line made in Step 2, then dividing that in half. For stairs below a landing, omit the middle blocking.

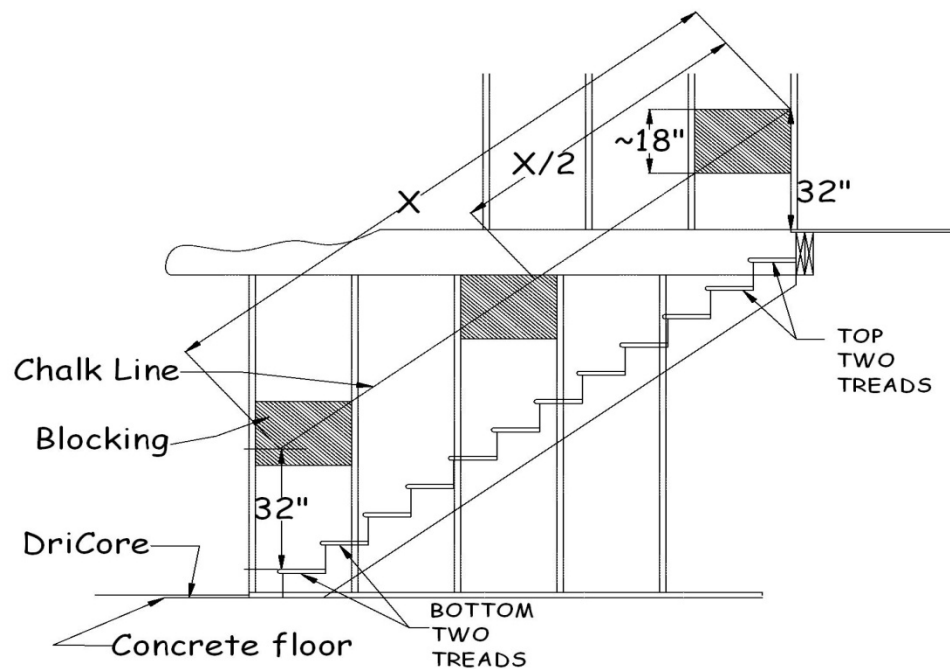

**Figure 10-7. Blocking For Handrail.**

5. Mark location of the blocks on the temporary stair treads to facilitate finding the blocks after plastering.

### 10.6.6. Blocking for Closet Pole Hangers

1. In each corner of every closet that will receive a closet pole, install a scrap piece of 2x4, at least 16” long, so there is something to attach the hanger to.
2. At the corner, make a mark 70” off the floor. Hold the piece vertically, place the top at that mark, and nail it flush to the 2x4 closet stud.

### 10.6.7. Blocking for Cold Air Returns

1. Blocking is required next to cold air returns to provide support for the register installation screw opposite the stud side.
2. Install blocking extending between each cold air return and the adjacent stud. Use a 9” high stack of six 2x4s on top of the bottom plate as shown in Figure 10-8.



Figure 10-8. Cold Air Return Blocking.

### 10.6.8. Blocking for Large Windows

1. Window openings 6’ or greater need additional “squash” blocking to support the longer expanse of the opening.
2. Cut four 9½” long pieces of 2x6. Create two blocks by nailing pairs of these pieces together. Position the blocks between the sill plate and the bottom of the decking under the K/J/J on each side of the window with the face of each block against the 2” foamboard. The blocks should fit tightly but can be further secured by toenailing 8d nails through the blocks into the sill plate.

### **10.6.9. Blocking for House-Mounted Mailbox**

1. Consult with the Construction Supervisor to determine if there will be a house-mounted mailbox installed. If yes, the top of the mailbox will be located on the latch side of the storm door, horizontally centered between the front door (and 4” lineal, if any) and the adjoining window (and 14” shutter, if any) and 43” above the porch surface. Refer to the House Plan or Construction Supervisor about the presence of lineals or shutters. If OSB sheathing exists at this location, no blocking is required; if not, blocking needs to be installed.
2. Pound a nail through the foamboard sheathing at the location described in Step 1 above to mark the location of the top, center of the mailbox. Install 2x6 blocking above and below this nail mark and spanning a minimum of 24” centered on the mark. Position blocking against the interior side of the sheathing.
3. Mark on the floor with black crayon the location and purpose of blocking for the Mailbox (MB). Spray over crayon marks with clear varnish to avoid crayon marks wearing off

### **10.6.10. Blocking for Porch Railing**

1. Consult with the Construction Supervisor to determine if a porch railing will be installed, and if so, its location. If yes, top and bottom porch railings will be attached to the house 5” and 36” above the porch surface. If OSB sheathing exists at these locations, no blocking is required; if not, blocking needs to be installed.
2. Pound a nail through the foamboard sheathing at the locations described in Step 1 above to mark the top and bottom porch rail attachment locations. For each nail mark, install 2x6 blocking centered vertically and horizontally on the mark and spanning a minimum of 12”. Position blocking against the interior side of the sheathing.
3. Mark on the floor with black crayon the location and purpose of blocking for the Porch Railing (PR). Spray over crayon marks with clear varnish to avoid crayon marks wearing off.

### **10.6.11. Blocking for House Number Mounting Board**

1. Consult with the Construction Supervisor to determine if a mounting board for house numbers will be installed, and if so, its location. If yes, the top of the mounting board will be located 70” above the porch or driveway surface, typically on the wall closest to the street. If OSB sheathing exists at this location, no blocking is required; if not, blocking needs to be installed.
2. Pound a nail through the foamboard sheathing at the location described in Step 1 above to mark the location of the top, center of the house number mounting board.

Install 2x6 blocking with its top at this mark and spanning a minimum of 24” centered on the mark. Position blocking against the interior side of the sheathing.

3. Mark on the floor with black crayon the location and purpose of blocking for the House Number Mounting Board (HN). Spray over crayon marks with clear varnish to avoid crayon marks wearing off